

# AtriCure®

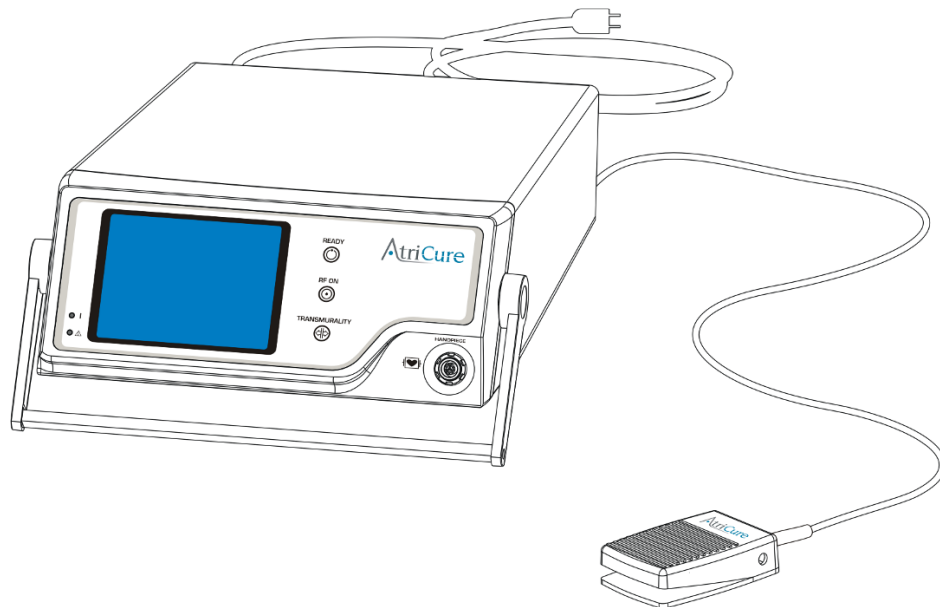

## ABLATION AND SENSING UNIT (ASU)

### USER'S MANUAL

# ASU2-115

# ASU3-230

### Rx ONLY

⚠ **CAUTION: Federal (USA) law restricts this device to sale by or on the order of a physician.**



European Representative:  
AtriCure Europe B.V.  
De entree 260  
1101 EE Amsterdam  
NL  
+31 20 7005560  
ear@atricure.com



AtriCure, Inc.  
7555 Innovation Way,  
Mason, Ohio 45040 USA  
+1 866 349 2342 (toll free)  
+1 513 755 4100 (phone)

***This Page Intentionally Left Blank***

## TABLE OF CONTENTS

<b>1. Getting Started</b> .....	<b>5</b>
1.1. System Description .....	5
1.2. Unpacking .....	6
1.3. Warnings and Precautions .....	6
1.4. EMC Guidance and Manufacturer’s Declaration .....	7
1.5. Responsibility of the Manufacturer .....	10
<b>2. The AtriCure Ablation and Sensing Unit (ASU)</b> .....	<b>10</b>
2.1. Device Description .....	10
2.2. ASU Front Panel – Illustration and Nomenclature .....	10
2.3 ASU Rear Panel – Illustration and Nomenclature .....	12
<b>3. Installing the ASU</b> .....	<b>13</b>
3.1. Transporting the ASU .....	13
3.2. Adjusting the Viewing Angle .....	13
3.3. Preparing the ASU For Use .....	13
3.4. Power Cord .....	14
3.5. Connecting and Disconnecting the Handpiece .....	14
3.6. Installing the Footswitch .....	14
<b>4. Instructions For Use</b> .....	<b>15</b>
4.1. Powering Up the ASU .....	15
4.2. Operating Modes .....	15
4.3. Audio Tones .....	16
4.4. Delivering RF Energy .....	16
<b>5. Troubleshooting</b> .....	<b>19</b>
5.1. No RF Power Output .....	19
5.2. Error Codes .....	19
5.3 Electromagnetic or Other Interference .....	19
<b>6. SYMBOLS GLOSSARY</b> .....	<b>20</b>
<b>7. Technical specifications</b> .....	<b>21</b>
7.1. RF Output .....	21
7.2. Mechanical Specifications .....	21
7.3. Environmental Specifications .....	21
7.4. Electrical Specifications .....	21
7.5. Fuses .....	21
7.6. Footswitch Specifications .....	21
7.7. Power and Voltage Output Restrictions .....	21
7.8. Equipment Type / Classification .....	22
<b>8. Preventive Maintenance and Cleaning of ASU</b> .....	<b>23</b>
8.1. Preventive Maintenance .....	23
8.2. Cleaning and Disinfecting .....	23
<b>9. Disposal</b> .....	<b>23</b>
<b>10. Accessories</b> .....	<b>24</b>
<b>10.1 ASB3, Switch Matrix Accessory</b> .....	<b>24</b>
<b>Warranties</b> .....	<b>27</b>
<b>DISCLAIMER</b> .....	<b>27</b>

***This Page Intentionally Left Blank***

## 1. GETTING STARTED

This manual, and the equipment, it describes are for use only by qualified medical professionals trained in the particular technique and surgical procedure to be performed.

Federal Law (US) restricts this device to sale by or on the order of a physician.

Please read all information carefully. Failure to properly follow the instructions may lead to serious surgical consequences.

Important: This manual is designed to provide instructions for use of the AtriCure Ablation and Sensing Unit (ASU) with the AtriCure Bipolar Handpiece (Isolator™ clamp, Isolator™ Transpolar™ pen, or CoolRail™ linear pen) **and AtriCure Accessory Devices (ASB 3)**. It is not a reference to surgical technique.

The AtriCure® ASU produces and delivers RF energy, in a bipolar mode, at a frequency of approximately 460 kHz, with a maximum output power ranging from 22.8 Watts up to 28.5 Watts for the Isolator™ clamps, 12.0 Watts up to 30.0 Watts for the Isolator™ Transpolar™ pen or CoolRail™ linear pen devices depending on the mode of operation. The AtriCure® ASU is capable of producing a maximum output power of 32.5 Watts under a 100 Ohm load, although no current AtriCure® Bipolar Handpiece uses power above 30 Watts. The operating mode is a function of the handpieces or pen and is set by the ASU. The AtriCure ASU is designed to operate only with an AtriCure Bipolar Handpiece, AtriCure Isolator Pen, or AtriCure CoolRail™ linear pen. The Footswitch is the input device used to activate RF energy delivery. Please refer to the handpiece and pen Instructions for Use for complete description of the indications and use of these devices.

For the user's convenience, the AtriCure Ablation and Sensing Unit will be referred to in this User's Manual as the "ASU". The AtriCure Bipolar Handpiece will be referred in this User's Manual as the "Handpiece".

This User's Manual provides a description of the ASU, its controls, displays, indicators, tones and a sequence for its operation with the Handpiece. This User's Manual also supplies other information of importance to the user. This manual is intended as a User's Manual only. Do not operate the ASU before thoroughly reading this manual.

### 1.1. System Description

As shown in Figure 1, the system is comprised of the following:

- AtriCure Bipolar Handpiece with integral cable (not shown)
- AtriCure Ablation and Sensing Unit (ASU)
- Footswitch
- Power cord.

Accessory devices are described in paragraph 10.

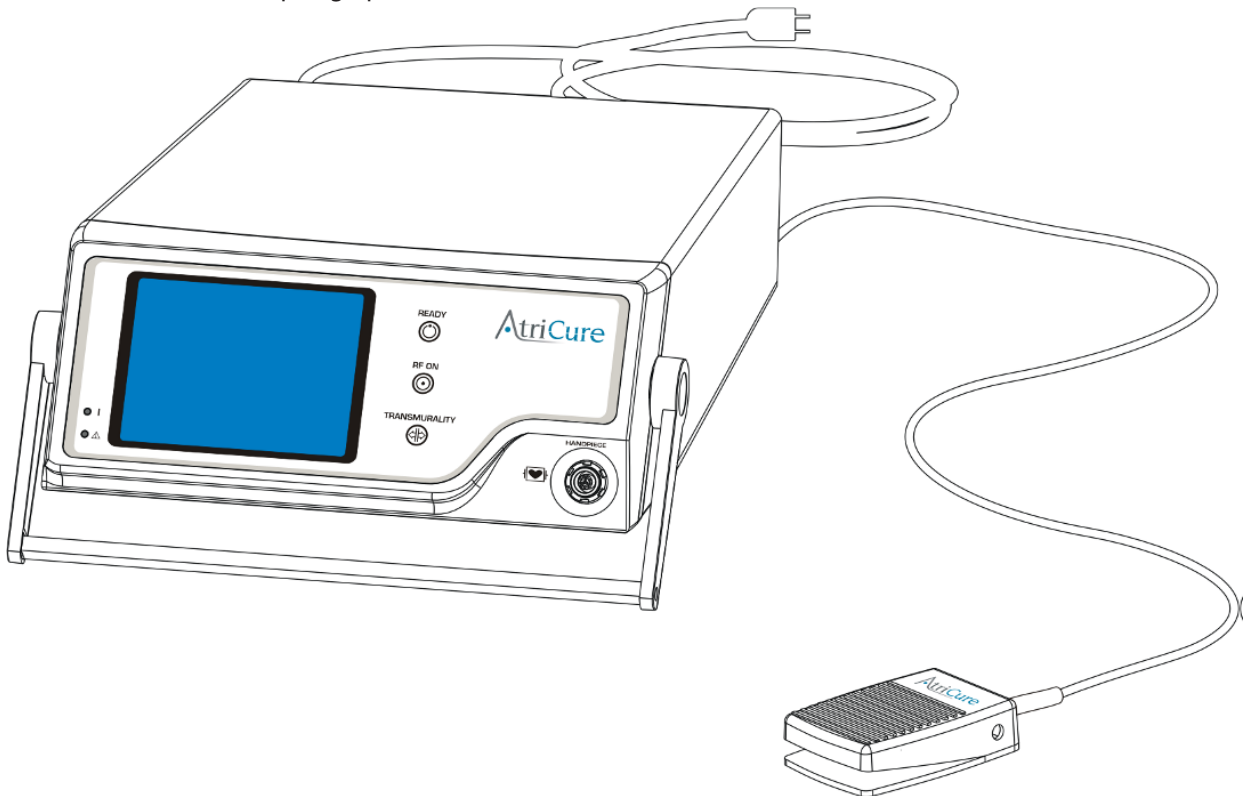

Figure 1 – ASU, Footswitch, and Power Cord

## 1.2. Unpacking

Lift the ASU, Footswitch, and Power Cord from the box and remove the protective wrapping. It is recommended that the original shipping box and protective wrapping be saved for future storing and/or transporting of the device.

## 1.3. Warnings and Precautions

The safe and effective use of RF energy is highly dependent upon factors under the control of the operator. There is no substitute for a properly trained operating room staff. It is important that the operating instructions supplied with the ASU be read, understood and followed before use.

### 1.3.1

#### **WARNINGS**

Do not operate the ASU before thoroughly reading this manual.

Do not use electrosurgical equipment unless properly trained to use it in the specific procedure being undertaken. This manual, and the equipment, it describes are for use only by qualified medical professionals trained in the particular technique and surgical procedure to be performed.

Do not use this device in the presence of flammable anesthetics; other flammable gases; near flammable fluids such as skin prepping agents and tinctures; flammable objects; or with oxidizing agents. Observe appropriate fire precautions at all times. Do not use this device in oxygen-enriched atmospheres, nitrous oxide (N<sub>2</sub>O) atmospheres, or in the presence of other oxidizing agents.

Fire Hazard: Electrosurgical accessories that are activated or hot from use can cause a fire. Do not place them near or in contact with flammable materials (such as gauze or surgical drapes). Avoid igniting endogenous gases.

Fire Hazard: Do not use extension cords.

Fire Hazard: To avoid igniting cleaning agents, use only non-flammable agents to clean and disinfect the ASU. If flammable agents are inadvertently used on the ASU, allow these substances to evaporate completely before operating.

Contact of the Handpiece with any metal (such as hemostats, clamps, staples, etc.) can result in unintended burn injuries. When not using the Handpiece, place it in a clean, dry nonconductive, and highly visible area not in contact with the patient. Inadvertent contact by an active Handpiece with the patient may result in burns.

When the ASU is activated, the conducted and radiated electrical fields may interfere with other electrical medical equipment. Refer to Section 5 for more information regarding potential electromagnetic or other interference, and advice regarding avoidance of such interference.

Electrosurgery should be used with caution in the presence of internal or external pacemakers. Interference produced with the use of electrosurgical devices can cause devices such as a pacemaker to enter an asynchronous mode or can block the pacemaker entirely. Consult the pacemaker manufacturer or hospital Cardiology department for further information when use of electrosurgical appliances is planned in patients with cardiac pacemakers.

Trip Hazard: Standard care should be used to reduce the risk of tripping on the Footswitch cable.

The use of accessories, transducers and cables other than those specified in accordance with the instructions or supplied by AtriCure, may result in increased emissions or decreased immunity of the equipment.

The ASU should not be used adjacent or stacked with other equipment, except for intended stacking with AtriCure's equipment in accordance with the instructions. The ASU normal use configuration should be observed to verify normal operation.

 The voltage selector is factory set and should not be changed by the user. The voltage selector and the power entry module must be set to the same voltage setting to prevent ASU malfunction and potential instrument damage.

 Electric Shock Hazard: Connect the ASU Power Cord to a properly grounded receptacle. Do not use power plug adapters.

 Electric Shock Hazard: Do not connect wet accessories to the generator.

 Electric Shock Hazard: Ensure that the Handpiece is correctly connected to the ASU and that no wires are exposed from the cable, connector or Handpiece.

### 1.3.2. PRECAUTIONS

- Use only with the AtriCure Handpieces intended for use with the ASU.
- Do not activate the ASU until the Handpiece is properly positioned in the patient.

- The activation tone and indicator are important safety features. Do not obstruct the activation indicator. Ensure that the activation tone is audible to personnel in the operating room prior to use. The activation tone alerts personnel when the Handpiece is active. Do not disable the audible tone.

-  Do not remove the cover of the ASU as there is a potential for electrical shock. Refer to authorized personnel for service.
- Use only the Footswitch provided with the ASU.
- The Power Cord of the ASU must be connected to a properly grounded receptacle. Extension cords and/or adapter plugs must not be used.

-  Do not wrap instrument cable around metal objects. Wrapping cables around metal objects may induce hazardous currents.
- To avoid shock, do not allow patients to come into contact with earth metal parts of the ASU. The use of antistatic sheeting is recommended.
- Studies have shown that smoke generated during electrosurgical procedures can be potentially harmful to surgical personnel. These studies recommend using surgical masks and adequately ventilating the smoke by using a surgical smoke evacuator or other means.
- When the ASU and Handpiece are used on a patient simultaneously with physiological monitoring equipment, ensure that the monitoring electrodes are placed as far as possible from the surgical electrodes. Be sure to position the Handpiece cables so that they do not come in contact with the patient or the other leads.
- Needle monitoring electrodes are not recommended for use when operating the ASU and Handpiece.
- Monitoring systems that incorporate high frequency current-limiting devices are recommended for use with the ASU and Handpiece.
- Failure of the ASU and Handpiece could result in unintended power output increases.

#### 1.4. EMC Guidance and Manufacturer’s Declaration

##### 1.4.1. Electromagnetic Requirements

The AtriCure Ablation and Sensing Unit (ASU) has been tested and found to comply with the limits for medical devices in IEC 60601-1-2:2007. These limits are designed to provide reasonable protection against harmful interference in a typical medical installation.

The ASU can radiate radio frequency energy and, if not installed, used, and serviced in accordance with electromagnetic compatibility information provided in the instructions, may cause harmful interference to other devices in the vicinity.

Portable and mobile RF communications equipment can also affect ASU performance and care should be taken to minimize such interference. However, there is no guarantee that interference will not occur in a particular installation.

If the ASU does cause harmful interference to other devices, which can be determined by turning the ASU off and on, the user is encouraged to try to correct the interference by one or more of the following measures:

- Reorient or relocate the receiving device.
- Increase the separation between the ASU and the other devices.
- Connect the ASU into an outlet on a circuit different from that to which the other device(s) are connected.
- Contact the AtriCure service representative for help.

##### 1.4.2. Electromagnetic Emissions

Guidance and manufacturer’s declaration – electromagnetic emissions		
The AtriCure Ablation and Sensing Unit (ASU) is intended for use in the electromagnetic environment specified below. The customer or the user of the ASU unit should assure that it is used in such an environment.		
Emissions test	Compliance	Electromagnetic environment – guidance
RF emissions CISPR 11	Group 1	The ASU unit uses RF energy only for its internal function. Therefore, its RF emissions are very low and are not likely to cause any interference in nearby electronic equipment.
RF emissions CISPR 11	Class A	The ASU unit is suitable for use in all establishments other than domestic and those directly connected to the public low-voltage power supply network that supplies buildings used for domestic purposes.
Harmonic emissions IEC 61000-3-2	Class A	
Voltage fluctuations/ flicker emissions IEC 61000-3-3	Complies	

### 1.4.3. Electromagnetic Immunity

Guidance and manufacturer's declaration – electromagnetic immunity			
The AtriCure Ablation and Sensing Unit (ASU) is intended for use in the electromagnetic environment specified below. The customer or the user of the ASU unit should assure that it is used in such an environment.			
IMMUNITY test	IEC 60601 test level	Compliance level	Electromagnetic environment – guidance
Electrostatic discharge (ESD) IEC 61000-4-2	± 6 kV contact ± 8 kV air	± 6 kV contact ± 8 kV air	Floors should be wood, concrete, or ceramic tile. If floors are covered with synthetic material, the relative humidity should be at least 30 %.
Electrical fast transient/burst IEC 61000-4-4	± 2 kV for power supply lines ± 1 kV for input/output lines	± 2 kV for power supply lines ± 1 kV for input/output lines	Mains power quality should be that of a typical commercial or hospital environment.
Surge IEC 61000-4-5	± 1 kV line(s) to line(s) ± 2 kV line(s) to earth	± 1 kV differential mode ± 2 kV common mode	Mains power quality should be that of a typical commercial or hospital environment.
Voltage dips, short interruptions and voltage variations on power supply input lines IEC 61000-4-11	<5 % UT (>95 % dip in UT) for 0,5 cycle  40 % UT (60 % dip in UT) for 5 cycles  70 % UT (30 % dip in UT) for 25 cycles  <5 % UT (>95 % dip in UT) for 5 s	<5 % UT (>95 % dip in UT) for 0,5 cycle  40 % UT (60 % dip in UT) for 5 cycles  70 % UT (30 % dip in UT) for 25 cycles  <5 % UT (>95 % dip in UT) for 5 s	Mains power quality should be that of a typical commercial or hospital environment. If the user of the ASU unit requires continued operation during power mains interruptions, it is recommended that the ASU unit be powered from an uninterruptible power supply or a battery.
Power frequency (50/60 Hz) magnetic field IEC 61000-4-8	3 A/m	3 A/m	Power frequency magnetic fields should be at levels characteristic of a typical location in a typical commercial or hospital environment.
<b>NOTE:</b> UT is the a.c. mains voltage prior to application of the test level.			



#### 1.4.4. EMC Guidance and Manufacturer's Declaration

Guidance and manufacturer's declaration – electromagnetic immunity			
The AtriCure Ablation and Sensing Unit (ASU) is intended for use in the electromagnetic environment specified below. The customer or the user of the ASU should assure that it is used in such an environment.			
IMMUNITY test	IEC 60601 TEST LEVEL	Compliance level	Electromagnetic environment – guidance
<p>Conducted RF IEC 61000-4-6</p> <p>Radiated RF IEC 61000-4-3</p>	<p>3 Vrms 150 kHz to 80 MHz</p> <p>3 V/m 80 MHz to 2.5 GHz</p>	<p>3 Vrms</p> <p>3 V/m</p>	<p>Portable and mobile RF communications equipment should be used no closer to any part of the ASU, including cables, than the recommended separation distance calculated from the equation applicable to the frequency of the transmitter.</p> <p>Recommended separation distance</p> $d = 1.2 \sqrt{P}$ <p><math>d = 1.2 \sqrt{P}</math> 80 MHz to 800 MHz</p> <p><math>d = 2.3 \sqrt{P}</math> 800 MHz to 2.5 GHz</p> <p>where P is the maximum output power rating of the transmitter in watts (W) according to the transmitter manufacturer and d is the recommended separation distance in meters (m).</p> <p>Field strengths from fixed RF transmitters, as determined by an electromagnetic site survey,<sup>a</sup> should be less than the compliance level in each frequency range.<sup>b</sup></p> <p>Interference may occur in the vicinity of equipment marked with the following symbol:</p> 
<p><b>NOTE 1:</b> At 80 MHz and 800 MHz, the higher frequency range applies.</p> <p><b>NOTE 2:</b> These guidelines may not apply in all situations. Electromagnetic propagation is affected by absorption and reflection from structures, objects, and people.</p>			
<p>a) Field strengths from fixed transmitters, such as base stations for radio (cellular/cordless) telephones and land mobile radios, amateur radio, AM and FM radio broadcast and TV broadcast cannot be predicted theoretically with accuracy. To assess the electromagnetic environment due to fixed RF transmitters, an electromagnetic site survey should be considered. If the measured field strength in the location in which the ASU is used exceeds the applicable RF compliance level above, the ASU should be observed to verify normal operation. If abnormal performance is observed, additional measures may be necessary, such as re-orienting or relocating the ASU.</p> <p>b) Over the frequency range 150 kHz to 80 MHz, field strengths should be less than 3 V/m.</p>			

### 1.4.5. Recommended Separation Distance

<b>Recommended separation distances between portable and mobile RF communications equipment and the AtriCure Ablation and Sensing Unit</b>			
The AtriCure Ablation and Sensing Unit (ASU) is intended for use in an electromagnetic environment in which radiated RF disturbances are controlled. The customer or the user of the ASU can help prevent electromagnetic interference by maintaining a minimum distance between portable and mobile RF communications equipment (transmitters) and the ASU as recommended below, according to the maximum output power of the communications equipment.			
Rated maximum output power of transmitter W	Separation distance according to frequency of transmitter m		
	150 kHz to 80 MHz $d = 1.2 \sqrt{P}$	80 MHz to 800 MHz $d = 1.2 \sqrt{P}$	800 MHz to 2.5 GHz $d = 2.3 \sqrt{P}$
0.01	0.12	0.12	0.23
0.1	0.38	0.38	0.73
1	1.2	1.2	2.3
10	3.8	3.8	7.3
100	12	12	23
<p>c) For transmitters rated at a maximum output power not listed above, the recommended separation distance <math>d</math> in meters (m) can be estimated using the equation applicable to the frequency of the transmitter, where <math>P</math> is the maximum output power rating of the transmitter in watts (W) according to the transmitter manufacturer.</p> <p>d)</p> <p>e) NOTE 1: At 80 MHz and 800 MHz, the separation distance for the higher frequency range applies.</p> <p>f)</p> <p>g) NOTE 2: These guidelines may not apply in all situations. Electromagnetic propagation is affected by absorption and reflection from structures, objects, and people.</p>			

### 1.5. Responsibility of the Manufacturer

AtriCure is responsible for safety, reliability, and performance of the equipment only if:

- Installation procedures in this manual are followed.
- Persons authorized by AtriCure carry out modifications or repairs.
- The electrical installation of the relevant room complies with local codes and regulatory requirements such as IEC and BSI.
- The equipment is used in accordance with the AtriCure User's Manual.

## 2. THE ATRICURE ABLATION AND SENSING UNIT (ASU)

This section provides a detailed description of the ASU including its function and operating features.

### 2.1. Device Description

The AtriCure® ASU produces and delivers RF energy, in a bipolar mode, at a frequency of approximately 460 kHz, with a maximum output power ranging from 12 Watts up to 30 Watts depending on the operating mode. The AtriCure® ASU is capable of producing a maximum output power of 32.5 Watts under a 100 Ohm load although no current AtriCure® Bipolar Handpiece uses power above 30 Watts. The operating mode is a function of the handpiece and is set by the ASU. The AtriCure ASU is designed to operate with the AtriCure Handpiece. The ASU and Handpiece are designed for use without a neutral electrode. The Footswitch is the input device used to activate RF energy delivery.

### 2.2. ASU Front Panel – Illustration and Nomenclature

An illustration of the ASU front panel is shown in Figure 2, below.

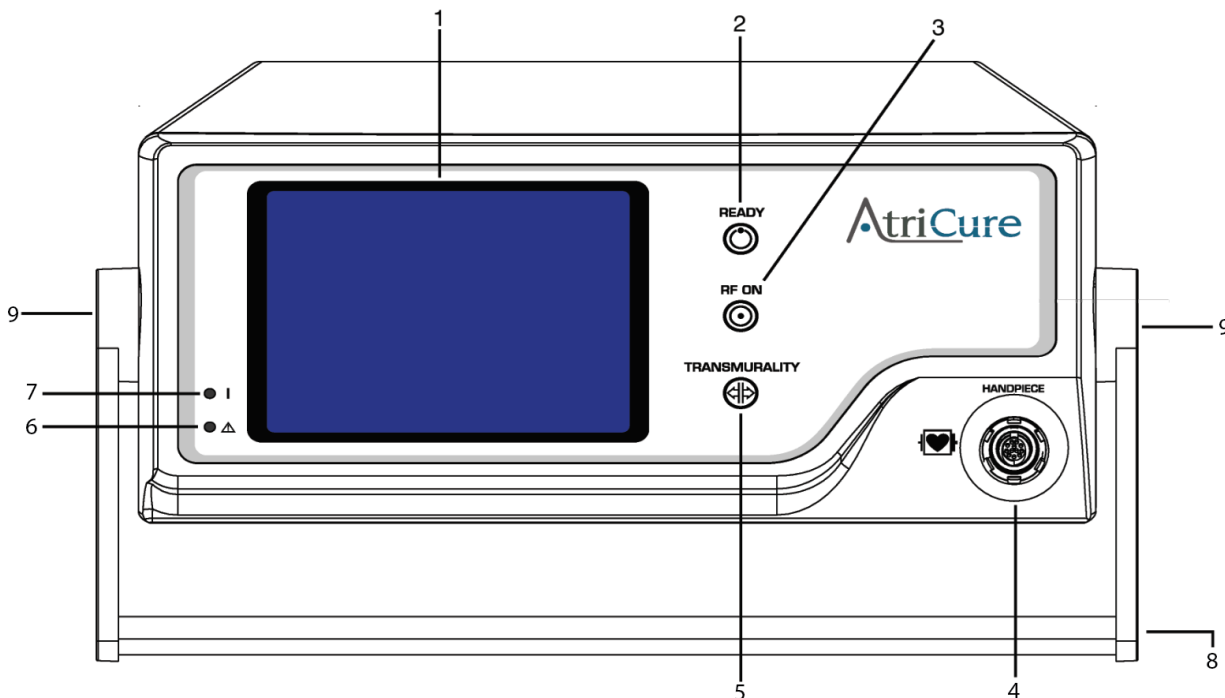

Figure 2 – ASU Front Panel





- [1] Tissue Conductance/ Power Graph Display
- [2] Ready Indicator
- [3] RF ON Indicator
- [4] Handpiece Receptacle
- [5] Transmurality Indicator
- [6] Fault Indicator
- [7] Power Indicator
- [8] Handle
- [9] Handle Adjustment Knobs

### Front Panel Displays

There is one display on the front panel of the ASU: the Tissue Conductance / Power Graph Display. This display is described below.

Display	Description
	<p><b>Tissue Conductance Graph Display – Isolator™ clamp (Default):</b></p> <p>During the ablation cycle the ASU displays a graph of tissue conductance (Current/Voltage) versus Time. The y-axis is Tissue Conductance and the x-axis is Time.</p> <p>When the Footswitch is disconnected or reconnected, the display of the tissue conductance graph is not affected. Refer to Section 4.4.3.</p>
	<p><b>Power Graph Display – Isolator™ Transpolar™ pen or CoolRail™ linear pen:</b></p> <p>During the ablation cycle the ASU displays a graph of power (Current Voltage) versus Time. The y-axis is Power and the x-axis is Time.</p> <p>When the Footswitch is disconnected or reconnected, the display of the power graph is not affected. Refer to Section 4.4.3.</p>

### Front Panel Indicators

Indicator	Description
	<b>POWER Indicator</b> – A Green LED indicates that the AC power is present and the ASU has been switched on.
	<b>FAULT Indicator</b> – This Red lamp indicates that a fault has occurred and requires that the power be cycled.
<b>READY</b> 	<b>READY Indicator</b> – This Green lamp indicates that the Footswitch and Handpiece are connected and the ASU is ready for use
<b>RF ON</b> 	<b>RF ON Indicator</b> – A Blue LED indicates that RF power is being output to the Handpiece. The RF power output is initiated by pressing the Footswitch.
<b>TRANSMURALITY</b> 	<b>TRANSMURALITY Indicator</b> – A Blue flashing LED indicates that the Transmurality Algorithm has been satisfied indicating that the user may terminate the ablation cycle.

### Front Panel Receptacle

Indicator	Description
	<b>HANDPIECE or ASU Accessory Receptacle</b> This 12-pin receptacle accepts the AtriCure Handpiece or connection cable to an accessory device. This connection is patient-isolated.

### 2.3 ASU Rear Panel – Illustration and Nomenclature

An illustration of the ASU rear panel is shown in Figure 3, below.

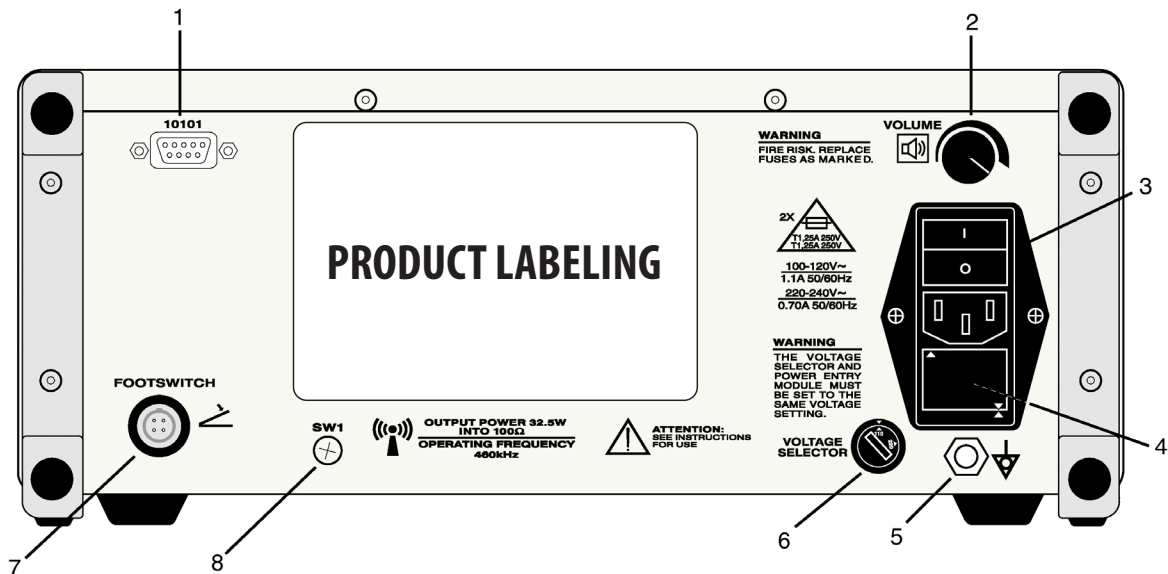

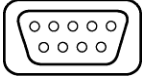
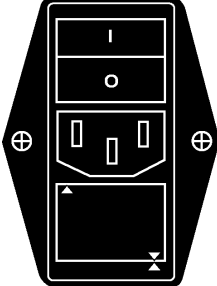

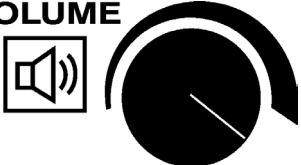
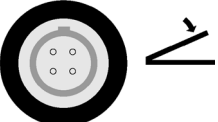



Figure 3 – ASU Rear Panel

- |      |                        |      |                               |
|------|------------------------|------|-------------------------------|
| [10] | Data Port              | [14] | Equipotential Ground Stud     |
| [11] | Speaker Volume Control | [15] | Input Voltage Selector Switch |
| [12] | Power Entry Module     | [16] | Footswitch Receptacle         |
| [13] | Fuse Box               | [17] | Service Access                |

## Rear Panel Functions

Graphic	Description
	<p>Equipotential Ground Stud – Provides a means of securely linking the earth grounds of the AtriCure ASU to other grounded equipment.</p>
<p><b>10101</b></p> 	<p>Data Port – For manufacturing and test purposes.</p>
	<p>Power Entry Module – This module contains both the ON/OFF switch and the fuses. The voltage is selected by the orientation of the fuse drawer as marked.</p> <p>Fuse Box – The Fuse Box contains fuses selected for the input voltage. See Technical Specifications in Section 7 of this manual.</p>
<p><b>VOLTAGE SELECTOR</b></p> 	<p>Input Voltage Selector Switch – The input voltage selector switch is pre-set at the factory to either 110V or 220V and should not be adjusted by the operator. This setting should only be adjusted by the manufacturer or by an authorized service representative.</p>
<p><b>VOLUME</b></p> 	<p>Speaker Volume Control – The audible volume level is adjustable via a rotary dial. The ASU includes a speaker for producing audible feedback to the user.</p>
<p><b>FOOTSWITCH</b></p> 	<p>Footswitch Receptacle – This receptacle accepts the Footswitch connector. The single momentary actuation pedal provides for the activation of RF power output.</p>
<p><b>SW1</b></p> 	<p>Service Access – For manufacturing and test purposes.</p>

### 3. INSTALLING THE ASU

Inspect the ASU for any signs of physical damage to the front panel, chassis or cover.

**NOTE:** If any physical damage is found, DO NOT USE THE UNIT. CONTACT AtrCure for a replacement.

All returns must be approved by AtrCure.

#### 3.1. Transporting the ASU

The handle may be used to carry the ASU. To change the positioning of the handle, depress both handle adjustment knobs simultaneously and move the handle to the desired location. Do not change the handle position when a Handpiece or Accessory Device is connected to the Handpiece receptacle.

#### 3.2. Adjusting the Viewing Angle

To change the viewing angle of the ASU Conductance Graph Display, adjust the handle position using the directions in Section 3.1., above.

#### 3.3. Preparing the ASU For Use

The ASU may be placed on a mounting cart or on any sturdy table or platform. It is recommended that carts have conductive wheels. Refer to hospital procedures or local codes for detailed information.

Provide at least four to six inches of space around the sides and top of the ASU for convection cooling. Under continuous use for extended periods of time, it is normal for the top and rear panel to be warm.

### 3.4. Power Cord

The ASU is shipped with an approved hospital grade power cord.

Plug the ASU into a grounded receptacle.

**NOTE:** Do not use extension cords or three-prong to two-prong adapters. The Power Cord assembly should be periodically checked for damaged insulation or connectors.

### 3.5. Connecting and Disconnecting the Handpiece

Connect the Handpiece directly to the ASU. Insert the Handpiece cable connector into the receptacle on the front panel of the ASU, ensuring that the arrow symbol on the connector is facing upward and oriented to the arrow symbol on the ASU receptacle.

**NOTE:** Typically, you will connect the Handpiece to the ASU when the ASU has been powered up and is in STANDBY operating mode (see Section 4.2 regarding the STANDBY mode). However, the Handpiece may be connected when powered up, or prior to powering up the ASU.

**NOTE:** Once you have connected the Handpiece, it cannot be disconnected from the ASU by pulling on the cable. To disconnect the Handpiece, pull back on the cable connector body and remove it from the ASU receptacle.

**NOTE:** Refer to the Handpiece instruction sheet for more detailed information about connecting the Handpiece to the ASU in a sterile environment.

### 3.6. Installing the Footswitch

#### 3.6.1. Inspect the Footswitch

Inspect the Footswitch for any signs of physical damage to the cable and connector. If physical damage is found or the Footswitch does not perform within specification, notify AtriCure. All returns must have approval from AtriCure.

#### 3.6.2. Connecting and Disconnecting the Footswitch

With the connector alignment arrow in the 12 o'clock position, push the Footswitch Connector into the Footswitch Receptacle on the rear panel of the ASU, shown in the Figure 4.

**NOTE:** Typically, you will connect the Footswitch to the ASU when the ASU has been powered up and is in STANDBY operating mode (see Section 4 regarding the STANDBY mode). However, the Footswitch may be connected when powered up, or prior to powering up the ASU.

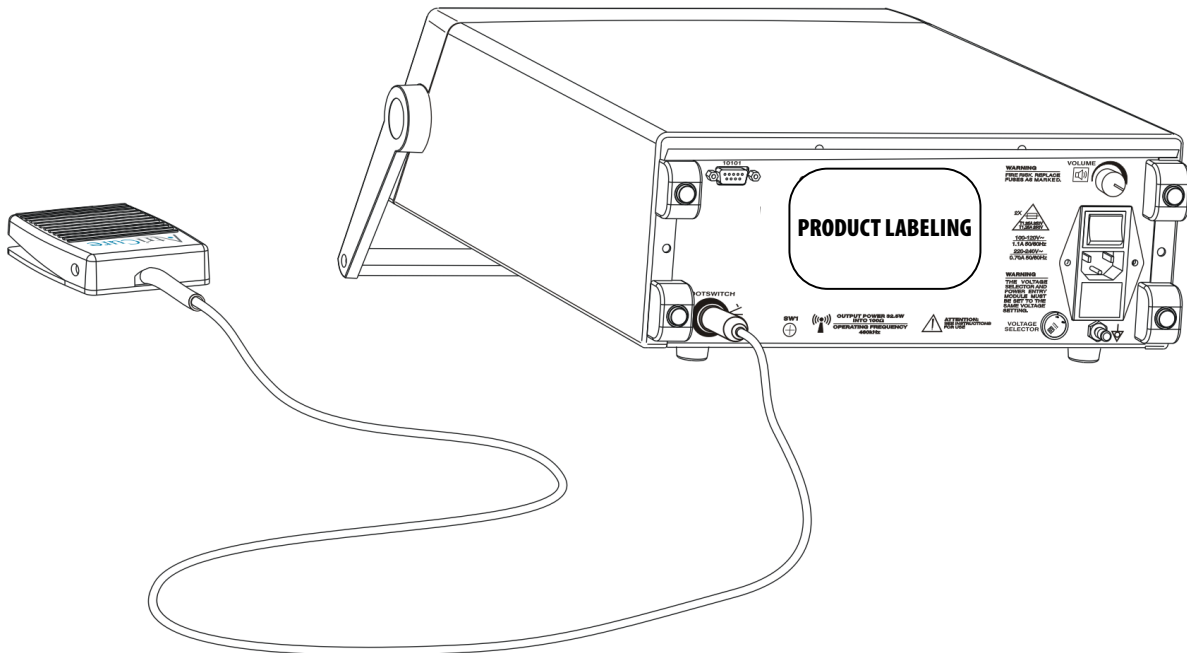

Figure 4 – Connecting the Footswitch to the ASU

#### 3.6.3. Preparing the Footswitch for Use

The Footswitch should be placed on a flat floor. It is recommended that the area near the Footswitch be kept dry to reduce the risk of slippage.

Appropriate precautions should be taken to ensure that the cable connecting the Footswitch to the ASU does not create a hazard in the operating room.

## 4. INSTRUCTIONS FOR USE

### 4.1. Powering Up the ASU

1. Ensure that the ASU has been plugged into a grounded receptacle.

**NOTE:** Do not use extension cords or three-prong to two-prong adapters. The power cord assembly should be periodically checked for damaged insulation or connectors.

2. Turn the power on using the ON/OFF switch located on the power entry module on the rear panel. When power is turned on; the system performs the System Self-Tests. See Figure 5. If all Self-Tests pass, the system transitions to the STANDBY mode. If any Self Test fails, the system transitions to the FAULT mode. The Self-Test generates two quick beeps at startup. The operator must verify that the beeps are generated.

**NOTE:** Refer to Section 4.2., below, for a full description of the STANDBY and FAULT modes, as well as all the other operating modes.



Figure 5 – Display Indicating SELF-TEST

### 4.2. Operating Modes

The ASU operates in one of five modes: STANDBY, READY, RF ON, ERROR and FAULT modes. These modes are shown on the lower left corner of the Conductance Display Graph. See Figure 6, below.

- **STANDBY Mode** – This mode is entered automatically after the ASU is successfully turned on or from READY Mode upon detection of a Handpiece or Footswitch disconnection. The LCD display message indicates the system is in the STANDBY Mode.
- **READY Mode** – This Mode is entered upon connecting both Handpiece and Footswitch while in the STANDBY Mode or from the ON Mode if the Footswitch has been depressed and released. The LCD display message indicates the system is in the READY Mode.
- **RF ON Mode** – This Mode is entered when the Footswitch is depressed while in the READY Mode. The system transitions from the RF ON Mode to the READY Mode upon 40-second time expiration or if the Footswitch is released.
- **ERROR Mode** – This Mode is entered upon detection of any recoverable error conditions during any Mode excluding the FAULT Mode. The system displays the corresponding error message, and upon Footswitch release, transitions to the READY Mode.
- **FAULT Mode** – This Mode is entered upon detection of any unrecoverable error condition during any Mode. The system is inoperable in this Mode until the power is cycled off, then on.

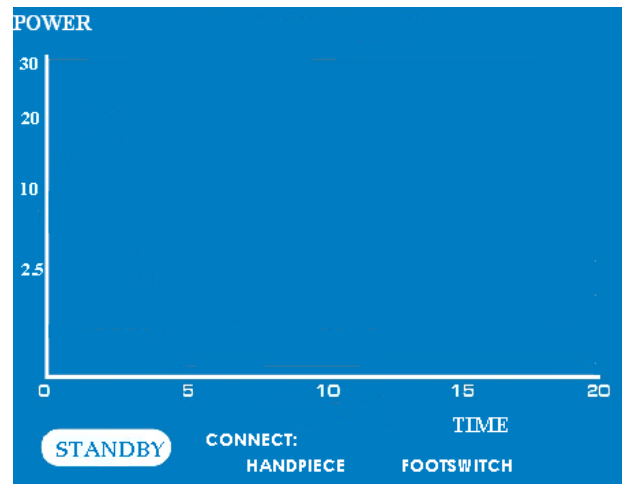
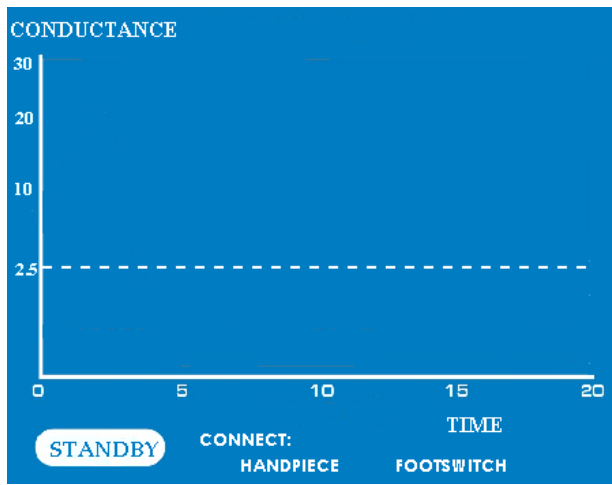

Figure 6 – Conductance and Power Display Graph Indicating STANDBY Mode

### 4.3. Audio Tones

The ASU uses 5 possible audio tones during its operation: Start Tone, Error Tone, Fault Tone, RF ON Tone, and the Transmurality Tone. You may control the volume of these tones using the Speaker Volume Control on the rear panel of the ASU (See Figure 3). Each of these 5 audio tones is described below.

Tone Name	Tone Description	Meaning for Operator:
Start Tone	Two quick beeps	This tone is generated when the power switch is placed in the “ON” position.
Error Tone	Constant low-pitched tone	This tone occurs while an error is present.
Fault Tone	Rapid succession of low-pitched beeps for 2 seconds duration	This tone occurs upon entering a fault mode.
RF ON Tone	Constant medium-pitched tone	This tone is generated when RF energy is being delivered to the Isolator™ clamp. This tone has a higher pitch than the Error tone.
	Varying medium-pitched tone	A discrete, decrementing tone in 10 second intervals is generated when RF energy is being delivered to the Isolator™ Transpolar™ pen. This tone has a higher pitch than the Error tone.
Transmurality Tone	Intermittent medium-pitched tone	This tone is generated in the RF ON mode when Transmurality is achieved. The Transmurality tone will continue, and RF energy will continue to be applied, until the Footswitch is released or until 40 seconds has elapsed. <b>This function is not applicable to the Isolator™ Transpolar™ pen.</b>

### 4.4. Delivering RF Energy

#### 4.4.1. Connect the Handpiece and Footswitch

Connect the Handpiece and Footswitch as described in Sections 3.5. and 3.6., and note the display to ensure connections are made. The display screen and Ready Indicator of the ASU should indicate that the RF generator is in the READY mode. See Figure 7.



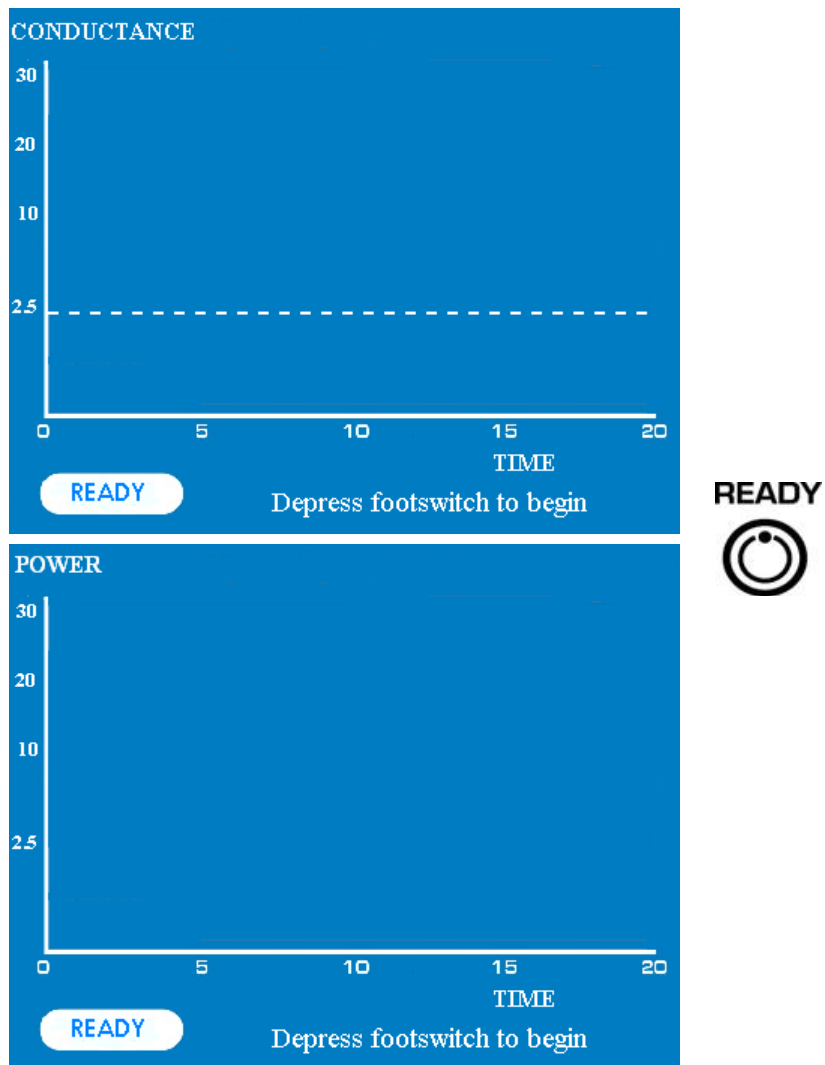

Figure 7 – Tissue Conductance Display Graph Indicating READY Mode for Isolator Handpieces (above) and Power Display Graph for Isolator™ Transpolar™ pen and Coolrail™ linear pen device (below).

**NOTE:** When the READY mode is entered from the RF ON mode, the previous plot is shown.

#### 4.4.2. Position the Handpiece

To position the Handpiece, follow the Instructions for Use provided with the Handpiece.

#### 4.4.3. Deliver RF Energy

Press the Footswitch to initiate RF energy output. RF energy output is terminated by releasing the Footswitch or at the end of 40 continuous seconds of energy delivery. The display screen of the ASU will indicate that the generator is in the RF ON mode. See Figures 8 and 9.

During the Isolator™ clamp operation, a real-time graph of measured tissue conductance is displayed on the LCD graphics screen with a +/- 20% tolerance. Using measurements of conductance, the ASU will determine when a transmural condition has been achieved.

When this condition has been achieved, the Blue Transmural indicator will flash and the audible tone emitted from the ASU will change from constant to intermittent, thus signaling to you that transmural condition has been achieved. If you do not release the Footswitch within 40 seconds, the system will automatically time-out and stop the ablation.

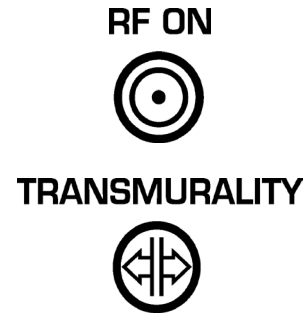
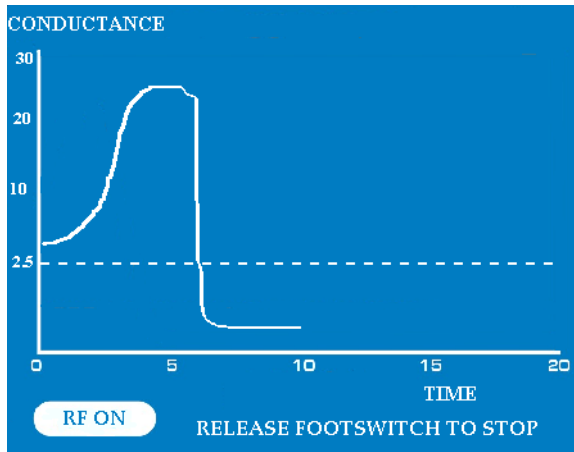

Figure 8 – Conductance Display Graph Indicating RF ON Mode

With the Isolator™ Transpolar™ pen and Coolrail™ linear pen, a real-time graph of measured power delivered to the tissue is displayed on the LCD graphics screen with a +/- 20% tolerance. The ASU will not indicate when a transmural condition has been achieved in this mode. Furthermore, if you do not release the Footswitch within 40 seconds, the system will automatically time-out and stop the ablation.

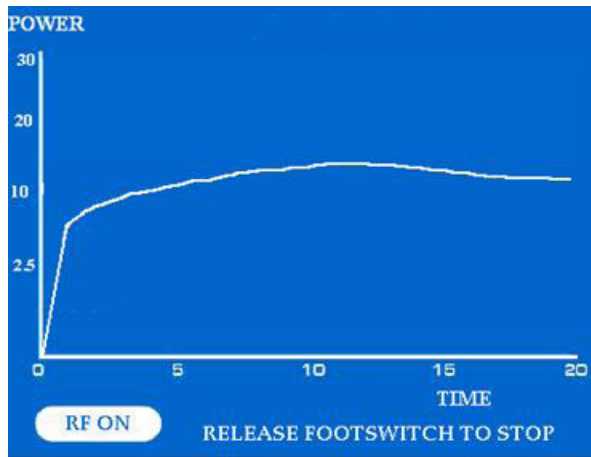

Figure 9 – Power Display Graph Indicating RF ON Mode

Both the conductance and the power graphs are on a 20-second scale. In some cases, the transmural condition will not be achieved within the 20 seconds shown on the Tissue Conductance Display Graph (not valid for Isolator™ Transpolar™ pen device or Coolrail™ linear pen). In such cases, the Graph will wrap to a second screen, which will display a continuation of the conductance for a maximum of 20 additional seconds. Figure 10, below, shows an example of this wrapping feature for an ablation requiring more than 20 seconds.

Similarly, for the Isolator™ Transpolar™ pen and Coolrail™ linear pen the power graph will wrap to a second screen for ablations lasting longer than 20 seconds.

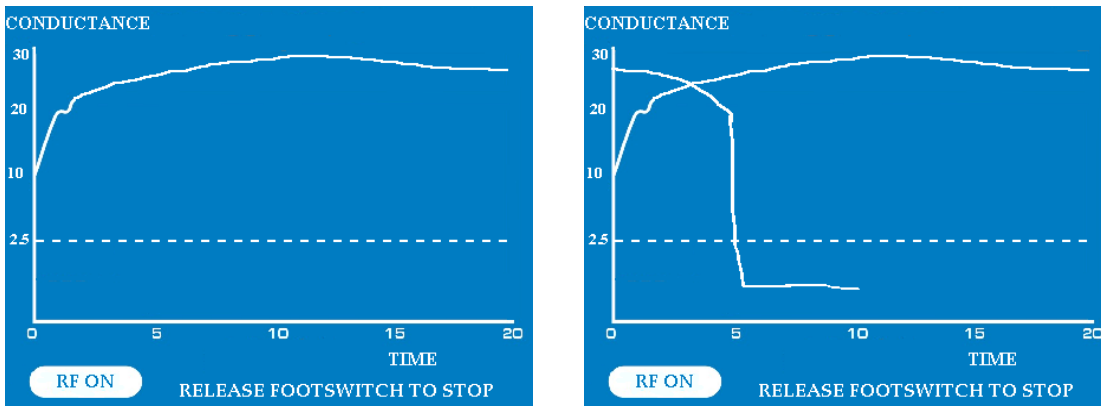

Figure 10 – Display Graph Wraps For An Ablation Lasting More Than 20 Seconds

## 5. TROUBLESHOOTING

Use the following sections to help troubleshoot possible problems with the ASU.

### 5.1. No RF Power Output

If there is no RF power output, attempt to correct this problem using the checklist below.

Possible Cause	Solution
ASU not turned on	Turn power on
ASU not plugged in	Confirm electrical connections and then turn power on
No Handpiece connected	Connect Handpiece
No Footswitch connected	Connect Footswitch
ASU in FAULT mode	Turn Power off and then on
ASU in STANDBY mode	Ensure that Handpiece and Footswitch are properly connected
Broken Handpiece cable	<b>Replace Handpiece</b>
Fault in Footswitch	<b>Replace Footswitch</b>
Fault in Handpiece	<b>Replace Handpiece</b>
Internal ASU failure	<b>Contact AtriCure Customer Service</b>

If the lack of ASU RF power output persists, contact the AtriCure service representative.

### 5.2. Error Codes

If a fault condition should occur, the Power Graph display on the front panel will display an error code. If an Error Code of E07 through E09, P01 through P10, P12 or F01 through F14 appears, try turning power off, then on. If the problem persists, contact AtriCure Customer Service.

Use the table below to attempt to resolve the following recoverable application errors.

LCD DISPLAY MESSAGE	DESCRIPTION	SOLUTION
Replace Handpiece H01	Invalid Handpiece Version	Replace Handpiece
Replace Handpiece H02	Time Expired Error: The Handpiece expiration date has been exceeded	Replace Handpiece
Replace Handpiece H03	Handpiece Electrical Problem	Replace Handpiece
Replace Handpiece H04	Invalid Handpiece Version	Replace Handpiece
Check Electrodes E01	Low Impedance Error: Handpiece electrodes are shorted	Check Electrodes or reposition jaws
Close Jaws E02	High Impedance Error: Handpiece jaws are open	<b>Close Handpiece Jaws</b>
Check Electrodes E03	Low Impedance Error: Handpiece electrodes are shorted	<b>Check Electrodes or reposition jaws</b>
Check Electrodes E04	Low Impedance Error: Handpiece electrodes are shorted	<b>Check Electrodes or reposition jaws</b>
Replace Handpiece E05	Open or defective thermocouple	<b>Replace Handpiece</b>
Check Footswitch E06	Switch Stuck Test Error: Footswitch closed while connecting	<b>Replace Footswitch</b>
Check Electrodes E10	Handpiece electrodes are shorted	<b>Check electrodes or reposition jaws</b>
Check Footswitch P10	Footswitch closed at power up	<b>Check Footswitch</b>

### 5.3 Electromagnetic or Other Interference

The ASU has been tested and found to comply with the limits for medical devices in IEC 60601-1-2:2001. These limits are designed to provide reasonable protection against harmful interference in a typical medical installation.

The ASU generates and can radiate radio frequency energy and, if not installed and used in accordance with the instructions, may cause harmful interference to other devices in the vicinity. However, there is no guarantee that interference will not occur in a

particular installation. If the ASU does cause harmful interference to other devices, which can be determined by turning the ASU off and on, the user is encouraged to try to correct the interference by one or more of the following measures:

- Reorient or relocate the receiving device.
- Increase the separation between the ASU and the other devices.
- Connect the ASU into an outlet on a circuit different from that to which the other device(s) are connected.
- Contact the AtriCure service representative for help.

Use the following sections to troubleshoot specific types of interference, including monitor (display) interference, neuromuscular stimulation, and pacemaker interference.

### 5.3.1. Monitor (Display) Interference

#### 5.3.1.1. Continuous Interference

3. Check the Power Cord connections for the ASU.
4. Check all other electrical equipment in the operation room for defective grounds.
5. If the electrical equipment is grounded to different objects, rather than a common ground, voltage differences can appear between the two grounded objects. The monitor may respond to these voltages. Some types of input amplifiers can be balanced to achieve optimum common mode rejection and may possibly correct the problem.

#### 5.3.1.2. Interference Only When ASU is Activated

1. Check all connections to the ASU, and active accessory to look for possible metal-to-metal sparking.
2. If interference continues when the ASU is activated and while the electrode is not in contact with the patient, the monitor is responding to radio frequencies. Some manufacturers offer RF choke filters for use in the monitor leads. These filters reduce interference while a generator is activated. RF filters minimize the potential for an electrosurgical burn at the site of the monitor electrode.
3. Check that the ground wires in the operating room are electrically consistent. All ground wires should go to the same grounded metal with wires that are as short as possible.
4. If the above steps do not remedy the situation, qualified service personnel should check the ASU.































### 5.3.2. Neuromuscular Stimulation

1. Stop the surgery.
2. Check all connections to the ASU and active electrodes to look for a possible metal-to-metal spark.
3. If no problems are found, the ASU should be checked by qualified service personnel for abnormal 50/60 Hz AC leakage current.

### 5.3.3. Pacemaker Interference

1. Check all connections.
2. Always monitor pacemaker patients during surgery.
3. Always keep a defibrillator available during electrosurgery on patients with pacemakers.
4. Consult the pacemaker manufacturer for specific recommendations.

## 6. SYMBOLS GLOSSARY

	Model Number		Catalog Number		Serial Number		Lot Number
	Unique Device Identifier		Caution		Service Access		Manufacturer
	Alternating Current		Fuses		Equipotential Terminal		Caution: Electrical Shock Hazard
	Non-ionizing electromagnetic radiation		Footswitch Connection		Non-Sterile		Waste Electrical and Electronic Equipment
	Does not contain phthalates		Not made with natural latex		Defibrillation Proof Type CF Applied Part		Volume Control
	Transit Temperature range		Transit Humidity range		Consult Instructions for Use		Dangerous Voltage
	READY		RF ON		Transmurality		UL Classification Mark (applicable to certain countries only)
<b>Rx ONLY</b>	Caution: Federal Law (US) restricts this device to sale by or on the order of a physician		Product complies with the requirements of directive 93/42/EEC		Authorized European Representative		

## 7. TECHNICAL SPECIFICATIONS

### 7.1. RF Output

- Frequency: 460 kHz  $\pm$ 5%, Quasi-sinusoidal
- ASU Maximum Power Output: 32.5 W at 100 $\Omega$
- HF Power and Voltage Output:

Device Code	Maximum Output Power	Maximum Output Voltage	Handpiece Type
A	28.5 W at 114 $\Omega$	57.0 Vrms	Isolator™ clamp
B	15.0 W from 20 $\Omega$ to 400 $\Omega$	77.5 Vrms	Isolator™ Transpolar™ pen
C	20.0 W from 31 $\Omega$ to 300 $\Omega$	77.5 Vrms	Isolator™ Transpolar™ pen Isolator™ linear pen
D	25.6 W at 127 $\Omega$	57.0 Vrms	Isolator™ clamp
E	22.8 W at 143 $\Omega$	57.0 Vrms	Isolator™ clamp
F	28.5 W at 114 $\Omega$	57.0 Vrms	<b>Isolator™ clamp</b>
G	28.5 W at 114 $\Omega$	57.0 Vrms	<b>Isolator™ clamp</b>
H	28.5 W at 114 $\Omega$	57.0 Vrms	<b>Isolator™ clamp</b>
J	12.0 W from 20 $\Omega$ to 500 $\Omega$	77.5 Vrms	<b>Isolator™ Transpolar™ pen</b>
K	25.0 W from 39 $\Omega$ to 240 $\Omega$	77.5 Vrms	<b>Isolator™ Transpolar™ pen, or Coolrail™ linear pen</b>
L	30.0 W from 47 $\Omega$ to 200 $\Omega$	77.5 Vrms	<b>Isolator™ Transpolar™ pen, or Coolrail™ linear pen</b>

### 7.2. Mechanical Specifications

- Size: 13" x 13.75" x 6" (32.5 cm x 34.4 cm x 15 cm) maximum.
- Weight: 15 lb. (9 kg) maximum.

### 7.3. Environmental Specifications

- Operational temperature: 10°C to 40°C
- Storage temperature: -35°C to +54°C
- Humidity: 15 to 90% relative humidity

### 7.4. Electrical Specifications

- 100-120V ~ 50/60 Hz
- 220-240V ~ 50/60 Hz

### 7.5. Fuses

- 100 -120V, 220-240V, ~50 / 60 Hz,: Replace fuses as marked:  
1.25A/250V, T-lag, 5 x 20 mm, UL Recognized, IEC Approved

### 7.6. Footswitch Specifications

- Moisture protection rating: IPX8

### 7.7. Power and Voltage Output Restrictions

The maximum power output of 28.5 W for the Isolator™ clamp is available at 114 $\Omega$  load for devices operating under device code "A, F, G, and H". Lower maximum output powers are available depending on the system operating mode. See Section 7.1.

The maximum power output of 15.0 W for the Isolator™ Transpolar™ pen is available between 40 $\Omega$  to 400 $\Omega$  load for device operating under device code "B". Lower maximum output powers are available depending on the system operating mode. See Section 7.1.

The maximum power output of 30.0 W for the Coolrail™ linear pen is available between 47 $\Omega$  to 200 $\Omega$  load for device operating under device code "L". Lower maximum output powers are available depending on the system operating mode. See Section 7.1.

The maximum power output of 20.0 W for the Isolator™ linear pen is available between 31 $\Omega$  to 300 $\Omega$  load for device operating under device code "C". Lower maximum output powers are available depending on the system operating mode. See Section 7.1.

At other load impedances, the ASU will reduce the available power to comply with the specified voltage and current limits. See Figure 11 and Figure 12.

The ASU is capable of producing a maximum output power of 32.5 Watts under a 100 Ohm load although no current AtriCure® Bipolar Handpiece uses power above 30 Watts.

The maximum output voltage depends on the device code, and can be either 57 Vrms or 77.5 Vrms. See Section 7.1.

### 7.8. Equipment Type / Classification

- Class 1 Equipment

#### ASU2 & ASU3 POWER OUTPUT

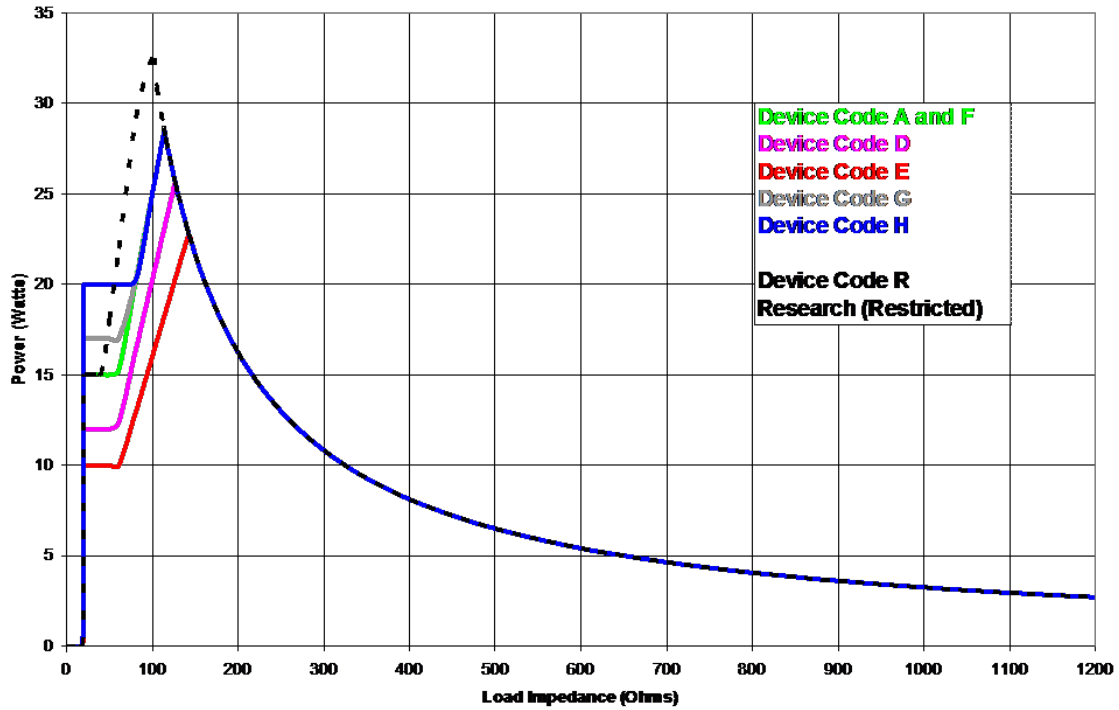

Figure 11 – Power vs. Load (clamp algorithm)

#### ASU2 & ASU3 POWER OUTPUT

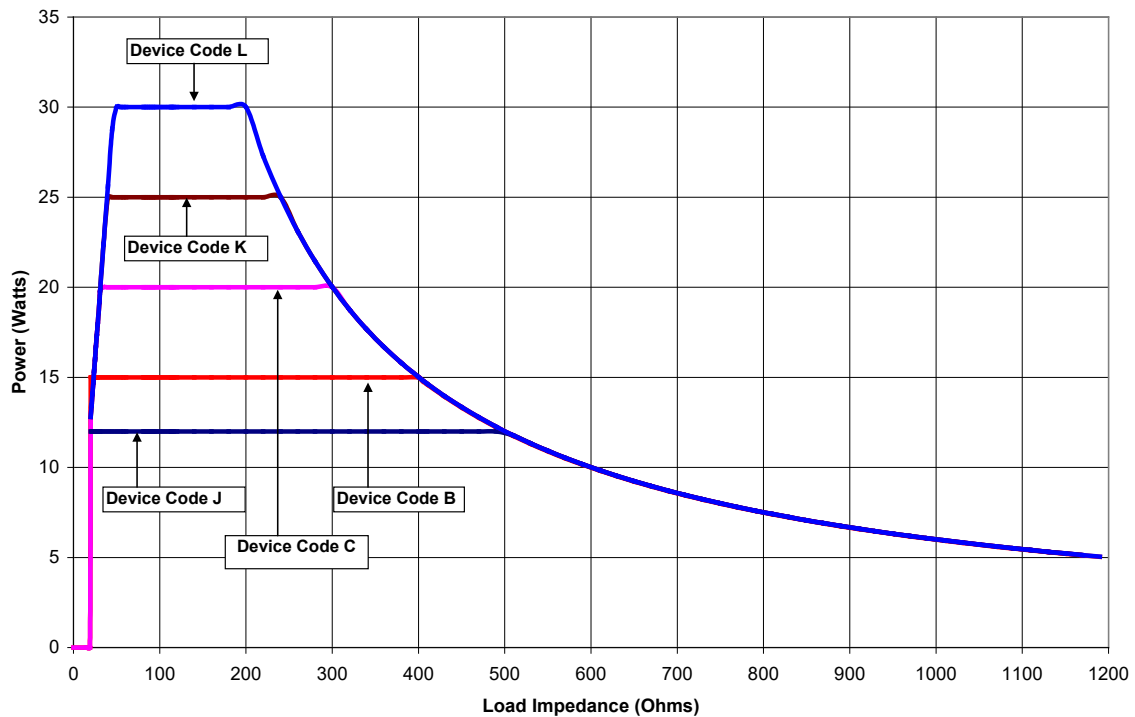

Figure 12 – Power vs. Load (pen algorithm)

## 8. PREVENTIVE MAINTENANCE AND CLEANING OF ASU

### 8.1. Preventive Maintenance

Perform annual preventative maintenance procedures to ensure all ASU components are functioning as defined within this manual. Pay particular attention to operational and safety features, including but not limited to:

- Electrical power cords for fraying, damage, and proper grounding
- AC power switch
- Indicator damage (Power On, Fault, Ready, RF ON, Transmurality)
- LCD display damage or loss of graphic information
- Handpiece connector damage, cracking or inability to insert and latch Handpiece plug
- Carrying handle damage, inability to latch or rotate
- Rubber feet damage, cracking or inability for the ASU to remain stable on a flat surface.
- Footswitch cord fraying or damage
- Footswitch connector damage cracking or inability to insert and latch footswitch plug
- Footswitch pedal damage check activation by pressing and releasing the pedal

Other medical equipment that may be used simultaneously with the ASU should also be inspected for damage. Specifically, check for insulation damage of monitoring electrode cables and endoscopically used accessories.

Visually inspect the footswitch for fluids or other infectious hazards. Clean as necessary using the instructions in Section 8.2.

The ASU does not have any serviceable parts. For servicing issues, contact AtriCure, Inc. at:

*AtriCure Incorporated  
7555 Innovation Way  
Mason, Ohio 45040 USA  
Customer Service:  
1-866-349-2342 (toll free)  
1-513-755-4100 (phone)*

### 8.2. Cleaning and Disinfecting

**NOTE:** Do not spray or pour liquids directly on the unit.

**NOTE:** The unit and/or accessories cannot be sterilized.

#### **⚠ WARNING ⚠**

Ensure Isopropyl Alcohol (IPA) is completely dry before operating the unit.

**⚠ CAUTION:** Avoid caustic or abrasive cleaners

#### **Guidelines**

The following guidelines are recommended for cleaning the unit. It is the user's responsibility to qualify any deviations from these processing methods.

1. Disconnect the unit or cart from the outlet before cleaning.
2. If the unit and/or accessories are contaminated with blood or other body fluids, they shall be cleaned before the contamination can dry (within two hours of contamination).
3. The outer surfaces of the unit and/or accessories shall be cleaned with 70% -90% Isopropyl alcohol (IPA) wipes for a minimum of two minutes. Do not allow fluids to enter the chassis.
4. Pay attention to all areas where fluids or soil may gather, such as under/ around the handles or any tight crevices/ grooves.
5. Dry the unit and/or accessories with a dry, white lint-free cloth.
6. Conduct a final confirmation of the cleaning process by visually inspecting the white cloth for remaining soil.
7. If soil remains on the white cloth, repeat steps 3 through 6.
8. After cleaning is complete, turn the unit on to perform Power On Self-Test (POST). If any errors are received, contact AtriCure to begin return process.

### 9. DISPOSAL

Follow local governing ordinances and recycling plans regarding disposal or recycling of device components.

## 10. ACCESSORIES

### 10.1 ASB3, Switch Matrix Accessory

The Switch Matrix provides a means of connecting multiple handpieces to the ASU and a means of selecting the input to the handpiece electrodes. The input is selected with the Switch Matrix knob. A cable with is provided to connect the Switch Matrix to the ASU.



Do not connect the ASB3 auxiliary device cable to supply mains (line voltage) operated equipment without evidence that the safety certification of the Accessory has been performed in accordance to the appropriate EN60601-1 and/or EN60601-1-1 harmonized national standard. Supply mains operated equipment may introduce dangerous leakage currents into the heart.

An auxiliary device (other than those listed in paragraph 10.2.2) may have an adverse effect on nearby radio or TV or medical equipment. There may also be cases when nearby electrical appliances adversely influence the auxiliary device, causing data errors or malfunction.

Auxiliary devices compatible for use with the Switch Matrix include:

- Any AtriCure Isolator™ Handpiece
- Any AtriCure Transpolar™ Pen
- Any AtriCure Coolrail™ linear pen
- OSCOR Model PACE 203H™
- MicroPace ORLab™ Stimulator/EP Recorder System



Read auxiliary device manual and observe warnings.

Any AtriCure handpiece or pen device may be connected to the Switch Matrix. AtriCure Devices will be functional when the device is connected to the correct receptacle and the Switch Matrix switch knob is turned to indicate the device for use.

Settings and procedures for the auxiliary device are determined according to the instructions for use provided with the auxiliary device.

ASB3, Switch Matrix Unit is shown below with the ASU.



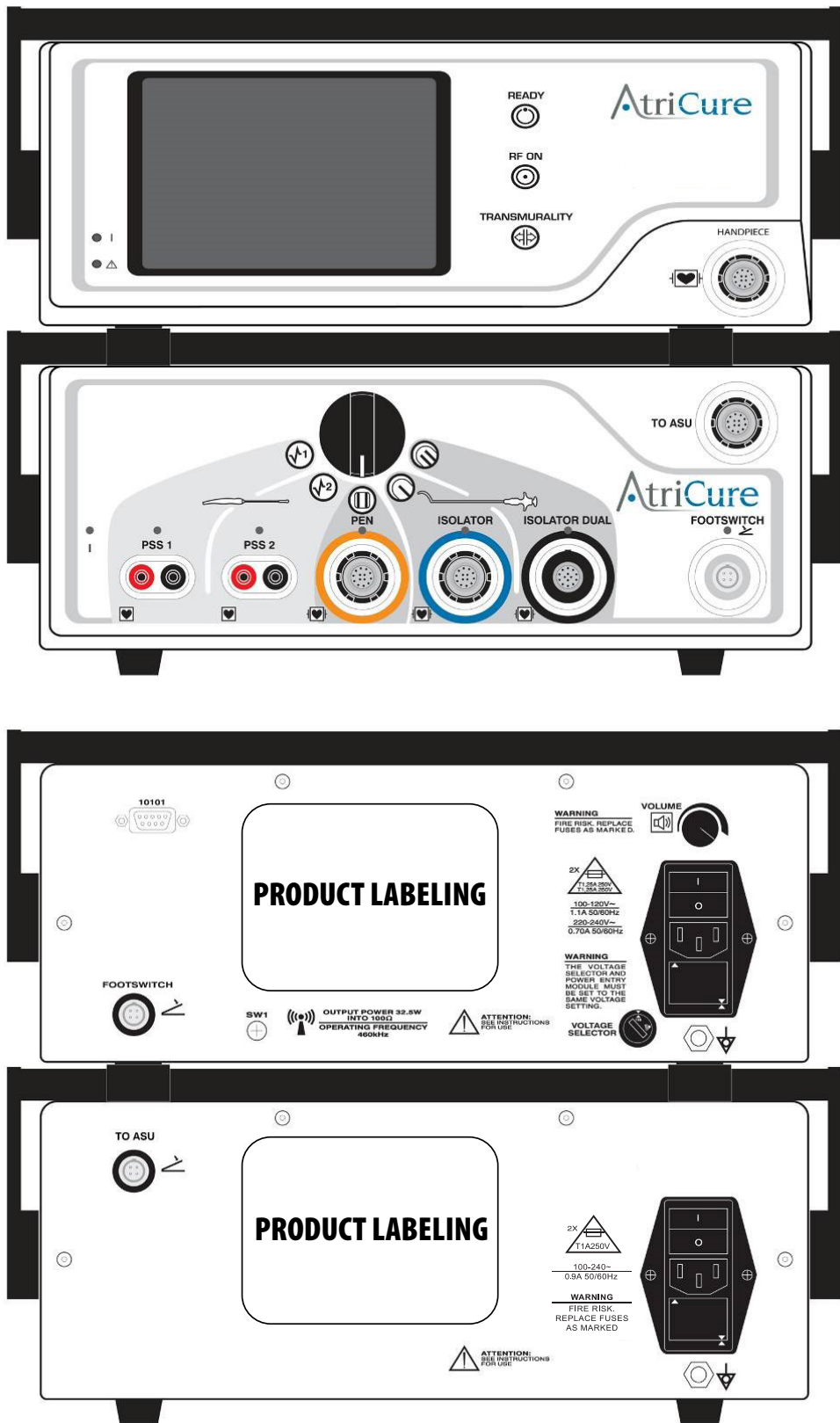

Switch Matrix set up is shown in the following figures.

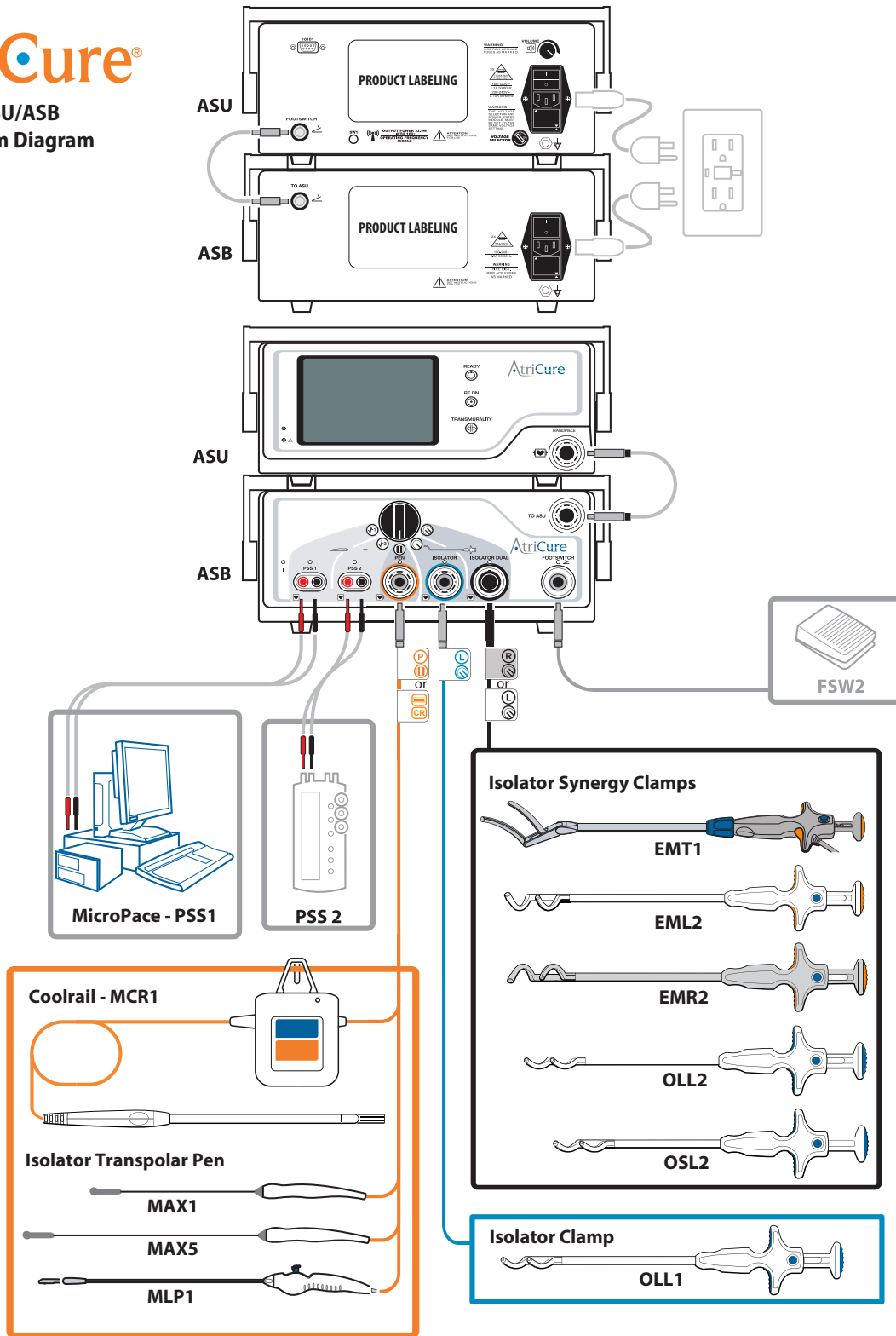

### 10. Accessories and Cables

- ASU/ASB Power Cord
- ASU/ASB Interface Cable
- Auxiliary Cable
- ASU Footswitch
- ASU/ASB Footswitch Interface Cable

**WARRANTIES**

**Limitation on Liability**

This warranty and the rights and obligations hereunder shall be construed under and governed by the laws of the State of Ohio, U.S.A.

AtriCure, Inc. warrants this product to be free from defects in material and workmanship under normal use and preventive maintenance for the respective warranty period shown below. AtriCure’s obligation under this warranty is limited to the repair or replacement, at its option, of any product, or part thereof, which has been returned to AtriCure, Inc. or its Distributor within the applicable time period shown below and which examination disclosed, to AtriCure’s satisfaction, to be defective. This warranty does not apply to any product, or part thereof, that has been: (1) adversely affected due to use with devices manufactured or distributed by parties not authorized by AtriCure, Inc. (2) repaired or altered outside AtriCure’s factory in a way so as to, in AtriCure’s judgment, affect its stability or reliability, (3) subjected to improper use, negligence or accident, or (4) used other than in accordance with the design and use parameters, instructions and guidelines for the product or with functional, operational or environmental standards for similar products generally accepted in the industry. AtriCure has no control over the operation, inspection, maintenance or use of its products after sale, lease or transfer, and has no control of the selection of Customer’s patients.

AtriCure’s products are warranted for the following periods after shipment to the original purchaser:

ATRICURE ABLATION AND SENSING UNIT .....	ONE (1) YEAR
ATRICURE SWITCH MATRIX .....	ONE (1) YEAR
ATRICURE RF AND FOOTSWITCH INTERFACE CABLES .....	ONE (1) YEAR
ATRICURE FOOTSWITCH .....	ONE (1) YEAR
GROUNDING ELECTRICAL CORD .....	ONE (1) YEAR

THIS WARRANTY IS IN LIEU OF ALL OTHER WARRANTIES, EXPRESS OR IMPLIED, INCLUDING THE WARRANTIES OR MERCHANTABILITY AND FITNESS FOR A PARTICULAR PURPOSE, AND OF ALL OTHER OBLIGATIONS OR LIABILITIES ON THE PART OF ATRICURE, INC. AND IS A PURCHASER’S EXCLUSIVE REMEDY. IN NO EVENT SHALL ATRICURE, INC. BE LIABLE FOR SPECIAL, INCIDENTAL OR CONSEQUENTIAL DAMAGES INCLUDING, WITHOUT LIMITATION, DAMAGES RESULTING FROM LOSS OF USE, PROFITS, BUSINESS OR GOODWILL.

AtriCure, Inc. neither assumes nor authorizes any other person to assume for it any other liability in connection with the sale or use of any of AtriCure Inc. products. There are no warranties that extend beyond the terms presented unless an extended warranty is purchased before the original warranty expires. No agent, employee or representative of AtriCure has any authority to change any of the foregoing or assume or bind AtriCure to any additional liability or responsibility. AtriCure, Inc. reserves the right to make changes to products built and/or sold by them at any time without incurring any obligation to make the same or similar changes on products previously built and/or sold by them.

**DISCLAIMER**

Users assume responsibility for approving the acceptable condition of this product before it is used, and for ensuring that the product is only used in the manner described in these instructions for use. Under no circumstances will AtriCure, Inc. be responsible for any incidental, special or consequential loss, damage, or expense, which is the result of the deliberate misuse of this product, including any loss, damage, or expense which is related to personal injury or damage to property.

***This Page Intentionally Left Blank***